

NETBA001

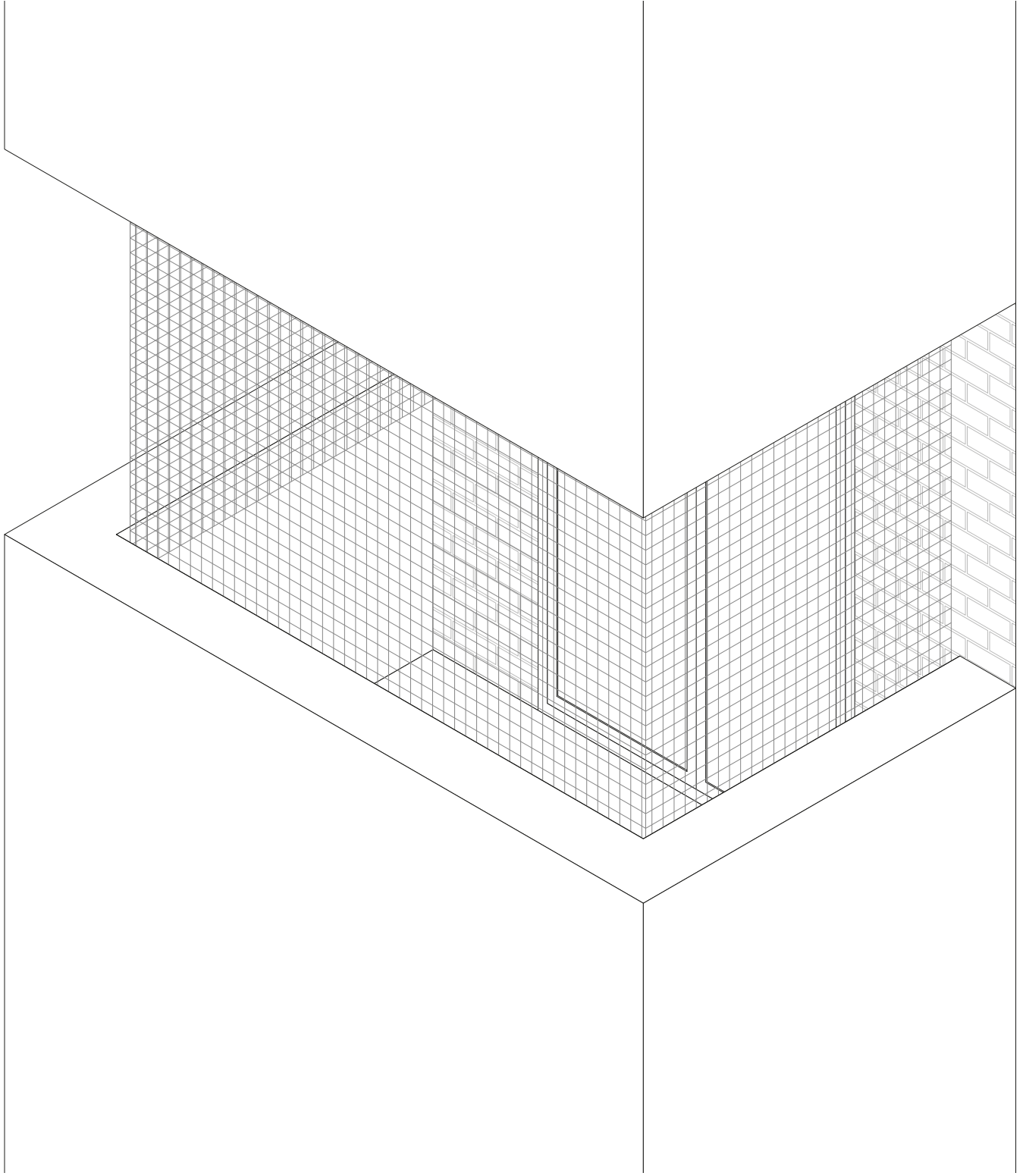

Important Safety Information

This is not a fall arrest system.
Working on a balcony can be dangerous.
You must read and follow the guidelines below and do your own risk assessment.

1. DIY competency required



2. Ensure that the area beneath the balcony is clear of pedestrians and do not drop anything from the balcony during installation

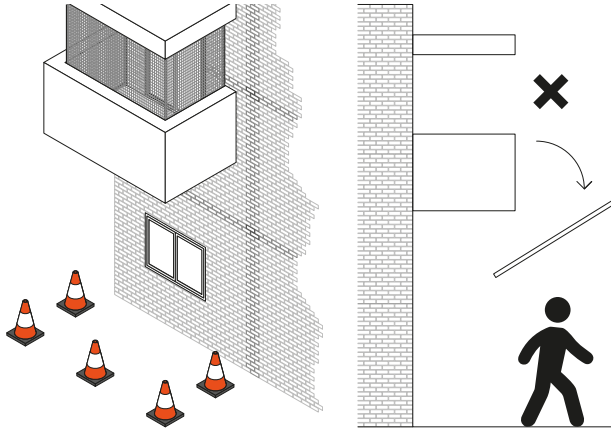

3. Do not obstruct fire exits

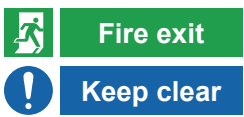

4. Only install on the inside of the balustrade and do not remove the balustrade

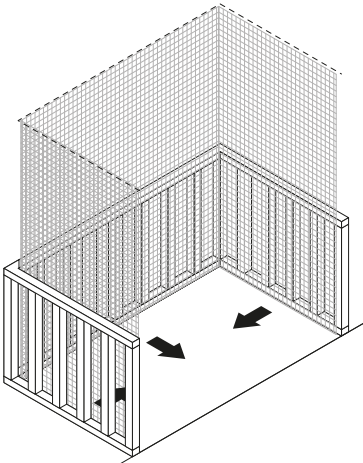

5. If using a step ladder, ensure it is in good condition, keep the step ladder between you and the work area, do not stretch or lean away from the step ladder, maintain 3 points of contact with the step ladder and have another person to assist and hold the ladder for additional stability



6. Do not lean on or climb frame under any circumstances

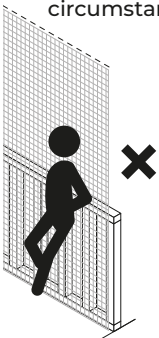

7. Do not attach anything to the netting or frame

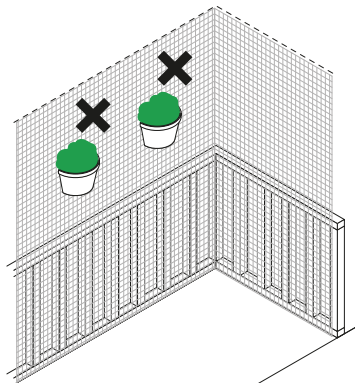

8. Do not leave children unattended



9. Regularly inspect the system to ensure no gaps or faults

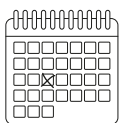

ProtectaPet
HABINATURAL SPACES FOR PETS

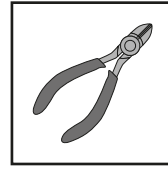
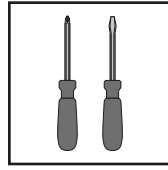
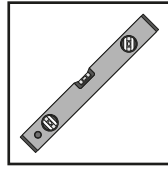
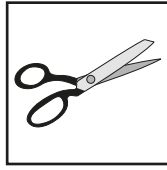
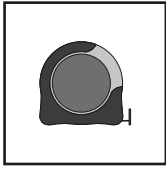
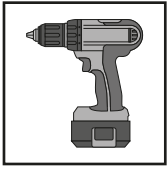
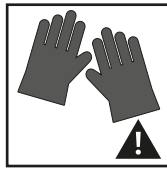

NETBA001

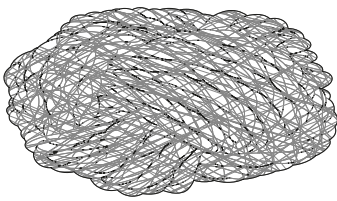
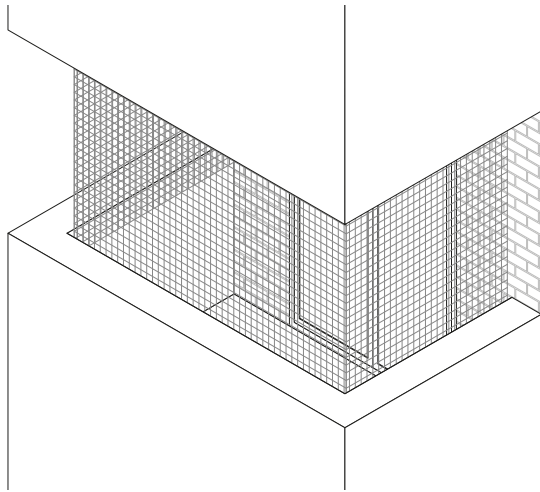

NETS2626 / NETS5226 / NETS7826



FIXGW001

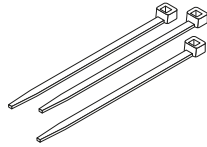

FIXCT103

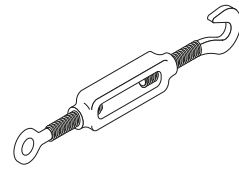

FIXWT001

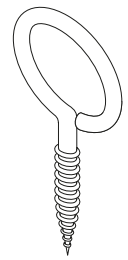

FIXKT010



1.

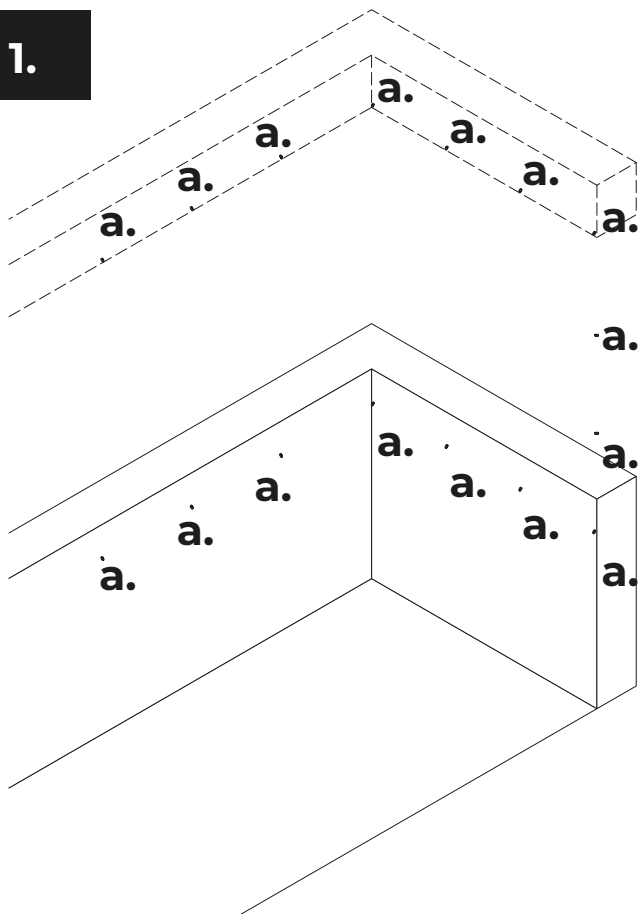

a.

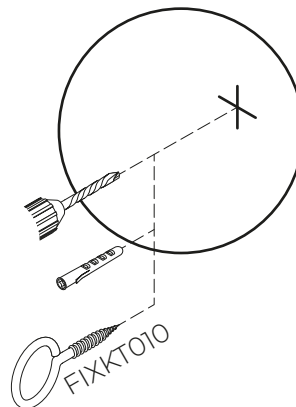

2.

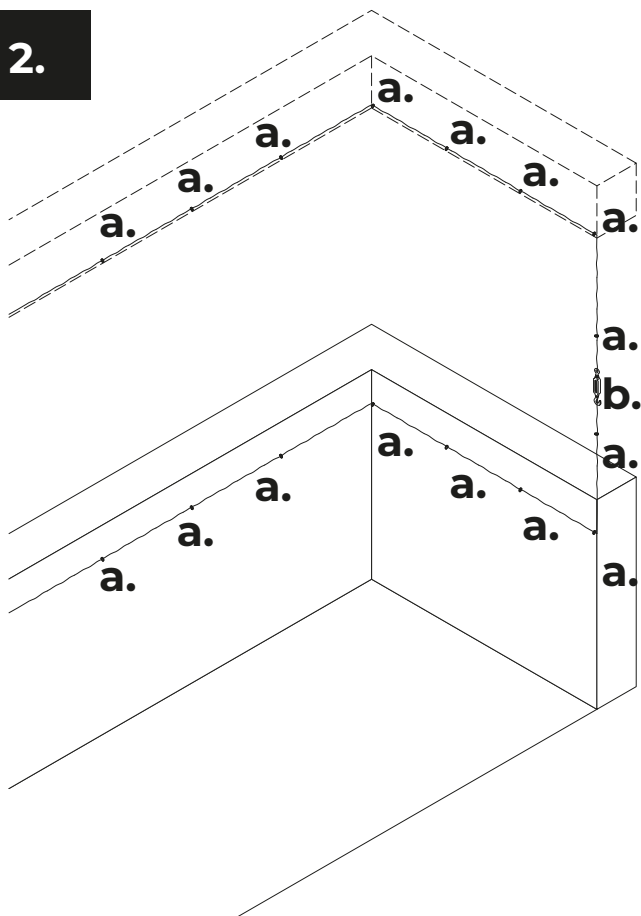

a.

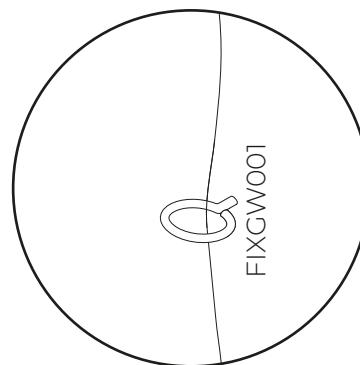

b.

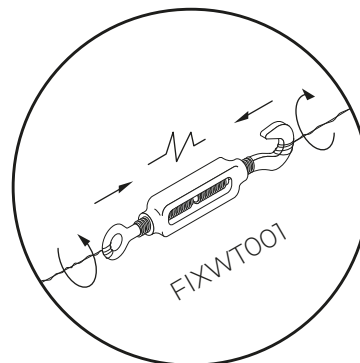

3.

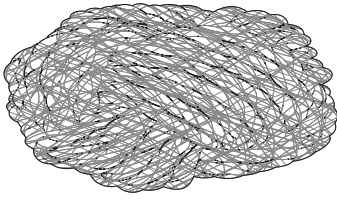

NETS2626 / NETS5226 / NETS7826

4.

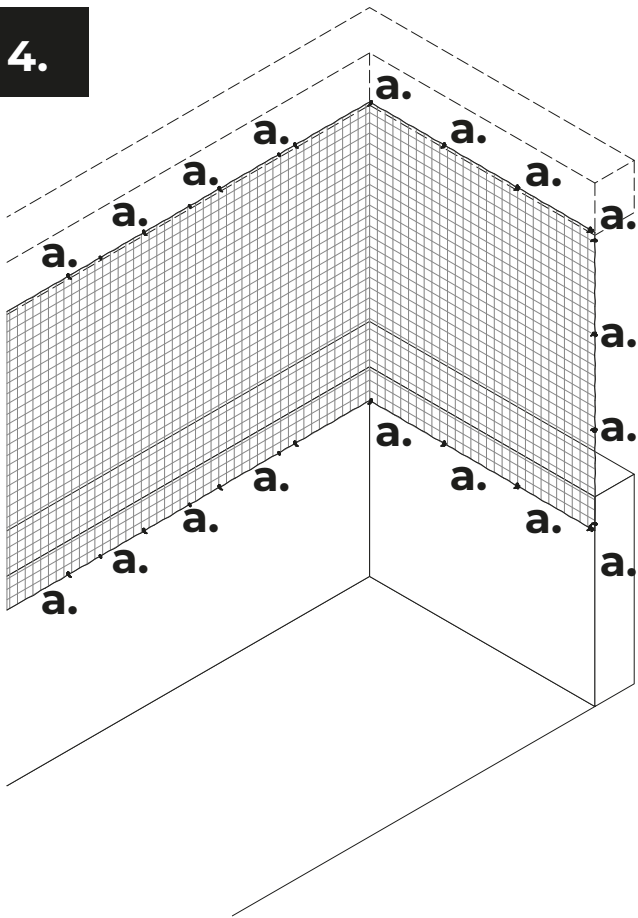

a.

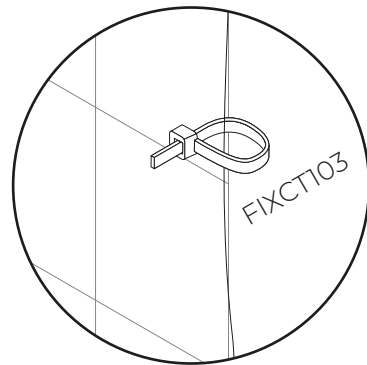

5.

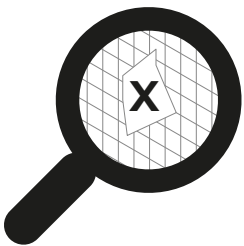

www.protectapet.com T: 0800 999 4008

info@protectapet.com

